



## ***TeraOhm 5kV***

*MI 2077*

## ***User Manual***

*Version 1.5, Code No. 20 750 378*

*Distributor:*

*Producer:*

METREL d.d.  
Ljubljanska 77  
SI-1354 Horjul

Tel.: +386 1 75 58 200  
Fax: +386 1 75 49 226  
E-mail: [metrel@metre.si](mailto:metrel@metre.si)  
<http://www.metrel.si>



Mark on your equipment certifies that this equipment meets the requirements of the EU (European Union) concerning safety and interference causing equipment regulations

© 2002 Metrel

No part of this publication may be reproduced or utilized in any form or by any means without permission in writing from METREL.

## Table of contents

<b>1. General introduction</b>	<b>4</b>
1.1. Features	4
1.2. Applied Standards	4
<b>2. Instrument Description</b>	<b>5</b>
2.1. Instrument Casing	5
2.2. Operator's Panel	5
2.3. Connectors	6
2.4. Bottom Section	7
2.5. Accessories	7
<b>3. Warnings</b>	<b>8</b>
<b>4. Performing measurements</b>	<b>10</b>
4.1. Switching on the instrument	10
4.2. Configuration	11
<b>5. Measurements</b>	<b>12</b>
5.1. Generally about DC High voltage testing	12
5.2. Guard terminal	15
5.3. Filter option	16
5.4. Voltage measurement	18
5.5. Insulation Resistance measurement	18
5.6. Diagnostic test	20
5.7. Step Voltage Insulation Resistance testing	24
5.8. Withstanding voltage	26
<b>6. Operation with Results</b>	<b>29</b>
6.1. Store, Recall and Clear Operation	29
6.2. Data transfer	31
<b>7. Maintenance</b>	<b>32</b>
7.1. Inspection	32
7.2. Battery Replacement	32
7.3. Cleaning	33
7.4. Calibration	33
7.5. Service	33
<b>8. Specifications</b>	<b>34</b>
8.1. Measurements	34
8.2. General specifications	36

# 1. General introduction

## 1.1. Features

The **TeraOhm 5kV** Tester is a portable battery / mains powered test instrument intended for testing of Insulation Resistance by using high test voltages of up to 5 kV. It operates on a SIMPLE and CLEAR basis.

The instrument is designed and produced with the extensive knowledge and experience acquired through many years of dealing with similar test equipment.

Available functions offered by the **TeraOhm 5kV** Tester:

- High Insulation Resistance measurement up to 5 T $\Omega$ 
  - Programmable test voltage 250 V up to 5 kV
  - Programmable timer 1s up to 30 min
  - Automatic discharge of tested object after measurement completion
  - Capacitance measurement
- Insulation Resistance measurement versus test voltage (step-up voltage)
  - Five discrete test voltages proportionately set within preset test voltage range
  - Programmable timer 1min up to 30 min per step
- Polarization Index PI, *Dielectric Absorption ratio and Dielectric Discharge ratio*
  - $PI = R_{INS}(t2) / R_{INS}(t1)$
  - $DAR = R_{01min} / R_{15s}$
  - $DD = I_{dis}(1min) / C \cdot U$
- Withstanding voltage (DC) up to 5.5 kV
  - Programmable ramp test voltage 250 V up to 5 kV
  - High resolution ramp (approx. 20 V per step)
  - Programmable threshold current
- Voltage and frequency measurement up to 600 V AC/DC

A dot matrix LCD offers easy-to-read results and all associated parameters. Operation is simple and clear; the operator does not need any special training (except reading and understanding this Users Manual) to operate the instrument.

The instrument allows storage of test results. Professional PC SW enables simple transfer of test results and other parameters in both directions between the test instrument and PC.

## 1.2. Applied Standards

Instrument operation	IEC / EN 61557-2
Electromagnetic compatibility (EMC)	EN 61326 Class B
Safety	EN 61010-1 (instrument), EN 61010-031 (accessories)

## 2. Instrument Description

### 2.1. Instrument Casing

The instrument is housed in a plastic casing that maintains the protection class defined in the general specifications. The casing is equipped with a carrying strap, which is intended for the instrument to be used hung around the operator's neck. Short technical specification is available on base of the housing.

### 2.2. Operator's Panel

The operator's panel consists of a dot matrix LCD, a rotary switch, and a keypad; see the figure below.

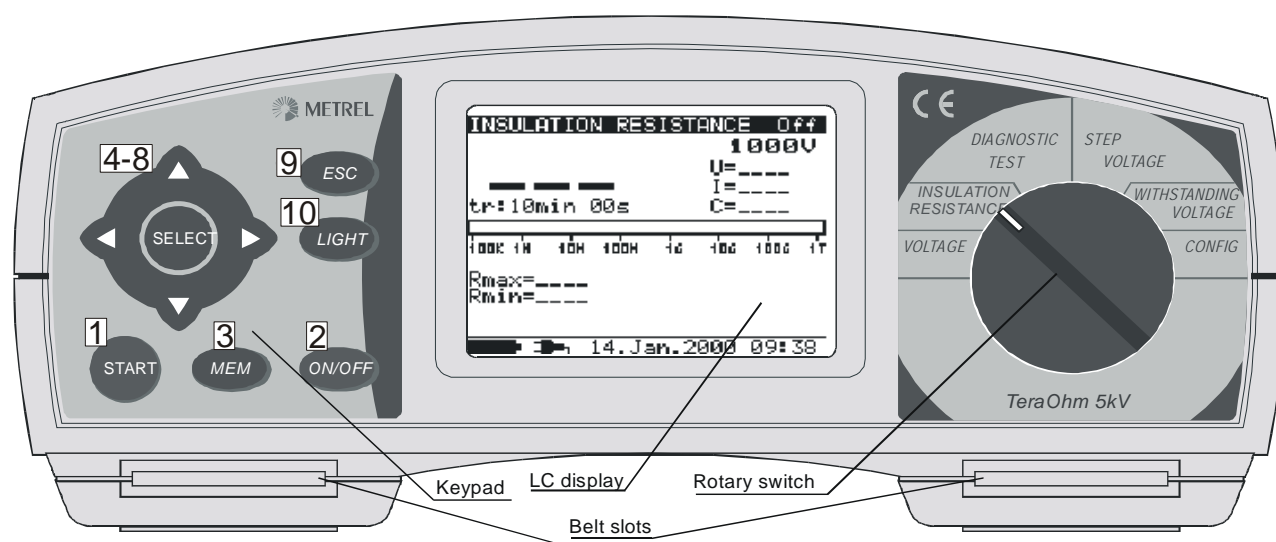

**Fig. 1.** Front panel

Legend:

- 1..... **START** key to start any measurement.
- 2..... **ON/OFF** key to switch the instrument ON or OFF.
- 3..... **MEM** key to store, recall and erase results.
- 4..... **SELECT** key to enter set-up mode for the selected function or to select the active parameter to be set.
- 5..... ▲ **cursor** key to select an option upward.
- 6..... ▼ **cursor** key to select an option downward.
- 7..... ◀ **cursor** key to decrease the selected parameter.
- 8..... ▶ **cursor** key to increase the selected parameter.
- 9..... **ESC** key to exit the selected mode.
- 10..... **Light** key to turn the display backlight ON or OFF.

## 2.3. Connectors

The **TeraOhm 5 kV** Tester contains the following connections:

- Connection of test leads to three banana safety sockets (1, 2, 3),
- Connection of the communication cable to the 9-pin RS 232 connector (4) and
- Mains supply cable connection to the mains socket (5).

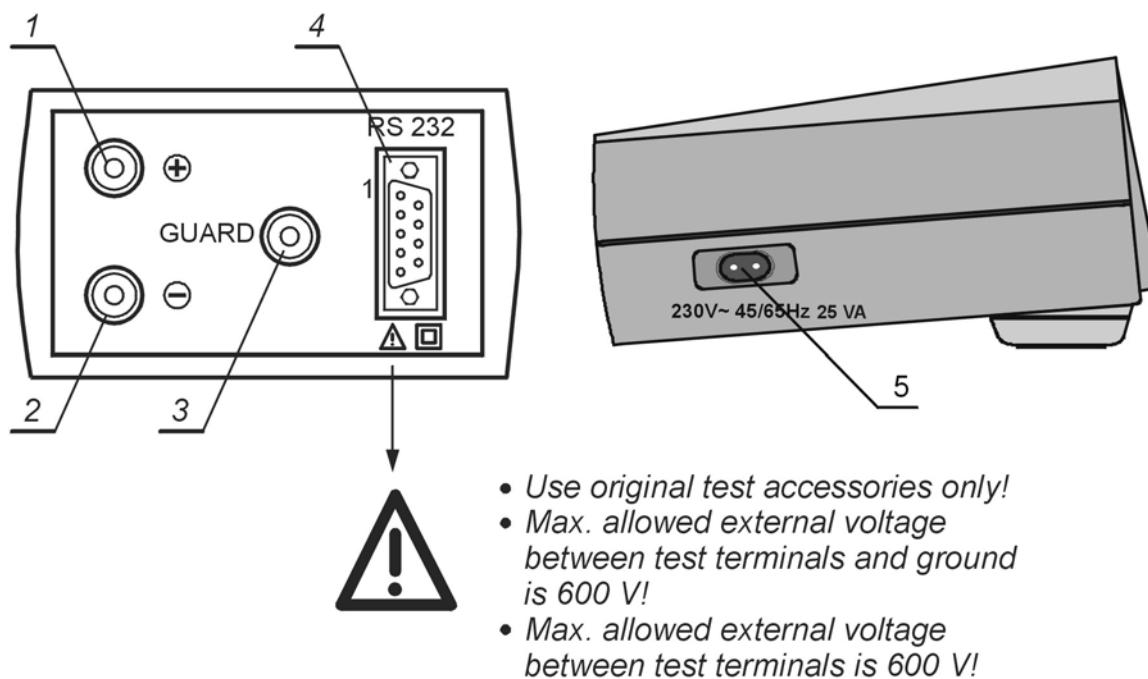

**Fig. 2.** Connectors

Legend:

- 1..... Positive Insulation Resistance **test terminal**.
- 2..... Negative Insulation Resistance **test terminal**.
- 3..... **GUARD** test terminal intended to lead away potential leakage current while measuring the Insulation Resistance.
- 4..... Galvanic separated **RS 232 connector** to connect the instrument to PC.
- 5..... Mains connector to connect the instrument to the mains supply.

## 2.4. Bottom Section

The bottom assembly is presented in the figure below. The carrying strap is fixed to the bottom section by means of a plastic cover (2).

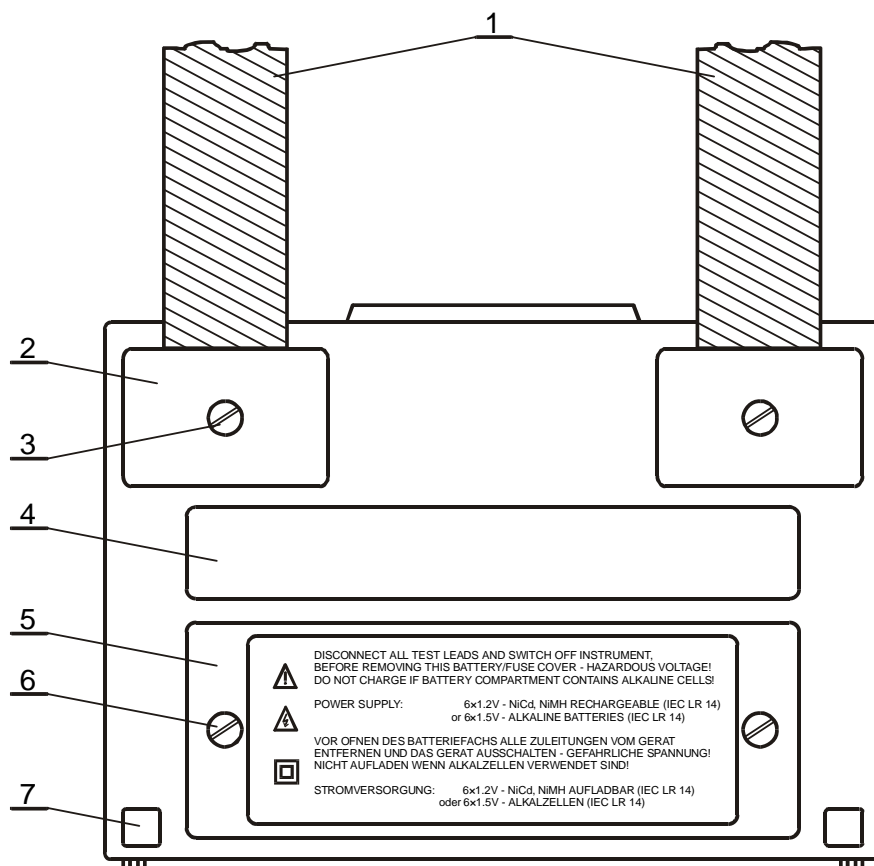

**Fig. 3.** Bottom section

Legend:

- 1..... Nylon strap (allows the operator to carry the instrument hung around the neck).
- 2..... Plastic cover (fixes the nylon strap to the instrument).
- 3..... Screw (unscrew to remove the carrying strap or to open the instrument).
- 4..... Label with measurement ranges.
- 5..... Battery/fuse compartment cover.
- 6..... Screw (unscrew to replace the batteries).
- 7..... Rubber foot.



## 2.5. Accessories

The accessories consist of standard and optional accessories. Optional accessories can be delivered upon request. See attached list for standard configuration and options or contact your distributor or see the METREL home page: <http://www.metrel.si>.

## 3. Warnings

In order to reach the highest level of operator's safety while carrying out various measurements and tests using the **TeraOhm 5kV** Tester, as well as to ensure that the test equipment remains undamaged, it is necessary to consider the following warnings:

### MEANING OF SYMBOLS

- ◆  symbol on the instrument means "Read the User Manual with special care!"
- ◆  symbol on the instrument means "Hazardous voltage higher than 1000 V may be present at the test terminals!"

### GENERAL PRECAUTIONS

- ◆ If the test equipment is used in a manner not specified in this Users Manual, the protection provided by the equipment may be impaired!
- ◆ Do not use the instrument and accessories, if any damage is noticed!
- ◆ Consider all generally known precautions in order to avoid the risk of electric shock while dealing with electric installations!
- ◆ Service intervention or recalibration procedure can be carried out only by a competent and authorized person!
- ◆ Only adequately trained and competent persons may operate the instrument.

### BATTERIES

- ◆ Disconnect all test leads and switch the power off before opening the Battery cover!
- ◆ Avoid connection to main supply when alkaline batteries are inserted, danger of explosion! Do not charge when alkaline batteries are fitted!

### EXTERNAL VOLTAGES

- ◆ Do not connect the instrument to a mains voltage different from the one defined on the label adjacent to the mains connector, otherwise the instrument may be damaged.
- Do not connect test terminals to an external voltage higher than 600 V AC or DC (CAT III environment) to prevent any damage on the test instrument!

### WORKING WITH THE INSTRUMENT

- ◆ Use only standard or optional test accessories supplied by your distributor!
- ◆ Equipment under test must be switched off i.e. de-energized before test leads are connected to the equipment.
- ◆ Do not touch any conductive parts of equipment under test during the test.
- ◆ Make sure that the tested object is disconnected (mains voltage disconnected) before starting the Insulation Resistance measurement!
- Do not touch the tested object whilst testing it, risk of electric shock!



- In case of a capacitive test object (long tested cable etc.), automatic discharge of the object may not be done immediately after finishing the measurement – “Please wait, discharging” message will be displayed.

#### **HANDLING WITH CAPACITIVE LOADS**

- ◆ Note that 40 nF charged to 1 kV or 1.6 nF charged to 5 kV are hazardous live!
- ◆ Never touch the measured object during the testing until it is totally discharged.
- ◆ Maximum external voltage between any two leads is 600 V (CAT III environment).

## 4. Performing measurements

### 4. 1. Switching on the instrument

#### Autocalibration

The instrument is switched ON by pressing the **ON/OFF** key. After turning on, the instrument first executes the autocalibration (Fig. 5).

It is necessary that the measuring test leads are disconnected during autocalibration. If not the instrument will require disconnection of the test leads and repeat switching OFF and ON.

After finishing the autocalibration, the instrument is prepared for normal operation.

Autocalibration prevents lowering of the accuracy when measuring very low currents. It compensates the effects caused by ageing, temperature and humidity changes etc. A new autocalibration is recommended when the temperature changes by more than 5°C.



Fig. 4. First introduction

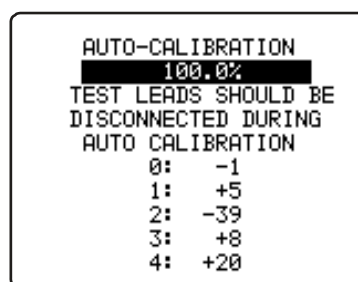

Fig. 5. Auto-calibration state

#### Note:

If the instrument detects incorrect state during the autocalibration, the following warning message will be displayed:

ERROR!

-TEST LEADS CONNECTED:

DISCONNECT AND SWITCH ON THE INSTRUMENT AGAIN

- CONDITIONS OUT OF RANGE: PRESS START TO CONTINUE

Possible reasons for out of range conditions are excessive humidity, too high temperature, etc. In this case it is possible to perform measurements but results could be out of technical specification.

#### Backlight operation

After turning the power on the LCD backlight is automatically turned on. It can be turned OFF and ON by simply clicking the **LIGHT** key.

Backlight turns off automatically approximately 10s after switching it ON, if the instrument is supplied by the internal battery.

## Off function

The instrument can be switched OFF only by pressing the **ON/OFF** key. The auto-off function is not available due to the possible long-term measurements.

## 4.2. Configuration

The configuration function enables the selection and adjustment of the parameters that are not directly involved in the measurement procedure (Figure 6).

In the lower section of the display the supply status, date and time is shown (same in all functions).

The following procedure must be carried out when adjusting some of the configuration parameters:

1. Use ↑ and ↓ arrows to select parameter (line) to be adjusted.
2. Use ← and → arrows to change the value of the selected parameter. If there are two or more sub-parameters in one line (e.g. date and time) then use the **SELECT** key to skip to the next sub-parameters and back.

### To clear all memory locations:

1. Select **Memory Clear** line using the ↑ and ↓ arrows.
2. Press the **SELECT** key, “**Press MEM to confirm!**” message will be displayed.
3. Press the **MEM** key to clear all memory locations or **ESC** to cancel the activity.

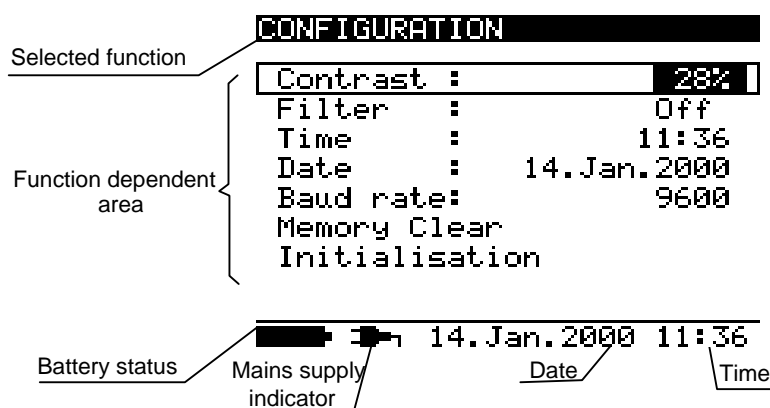

**Fig. 6.** Configuration state

Parameter	Value	Note
<b>Contrast</b>	0%..100%	Adjustment of the LCD contrast
<b>Filter</b>	Fil1, Fil2, Fil3, Off	Selection of noise rejecting filter, see the chapter 5.3. Filter Option
<b>Time</b>		Set real time (hour : minute)
<b>Date</b>		Set current date (day-month-year)
<b>Baud rate</b>	2400, 4800, 9600, 19200	Speed of data transfer in communication mode
<b>Memory clear</b>		Clear all memory locations
<b>Initialization</b>		For internal factory and service maintenance only!
<b>DIAG. Starting time</b>	0%..90%	Adjustment of start of timer in DIAGNOSTIC TEST functions, according the Unominal.

Table 1. Configuration parameters

## 5. Measurements

### 5.1. Generally about DC High voltage testing

#### The purpose of insulation tests

Insulating materials are important parts of almost every electrical product. The material's properties depend not only on its compound characteristics but also on temperature, pollution, moisture, ageing, electrical and mechanical stress, etc. Safety and operational reliability require the regular maintenance and testing of the insulation material to ensure it is kept in good operational condition. For testing the insulation materials high voltage test methods are applied.

#### DC vs. AC testing voltage

Testing with DC voltage is widely accepted as being useful as well as AC and / or pulsed. DC voltage can be used for breakdown tests especially where high capacitive leakage currents interfere with measurements using AC or pulsed voltage. It is mostly applied for measurement tests of the insulation resistance. The voltage in this type of test is defined by the appropriate product application group. It is lower than the voltage for the withstanding test so the tests can be applied more frequently without stressing the tested material.

#### Typical insulation tests

In general, insulation resistance tests consist of the following possible procedures:

- Simple insulation resistance measurement also called spot test;
- Measurement of voltage dependence of the insulation resistance;
- Measurement of time dependence of the insulation resistance;
- Test of recovered charge after the dielectric discharge.

The results of this test can indicate whether the replacement of the insulation system is needed.

Typical examples, where testing insulation resistance and its diagnosis are recommended, are transformer and motor insulation systems, cables and other electrical equipment.

#### Electrical representation of insulating material

The following figure represents the equivalent electrical circuit of insulating material

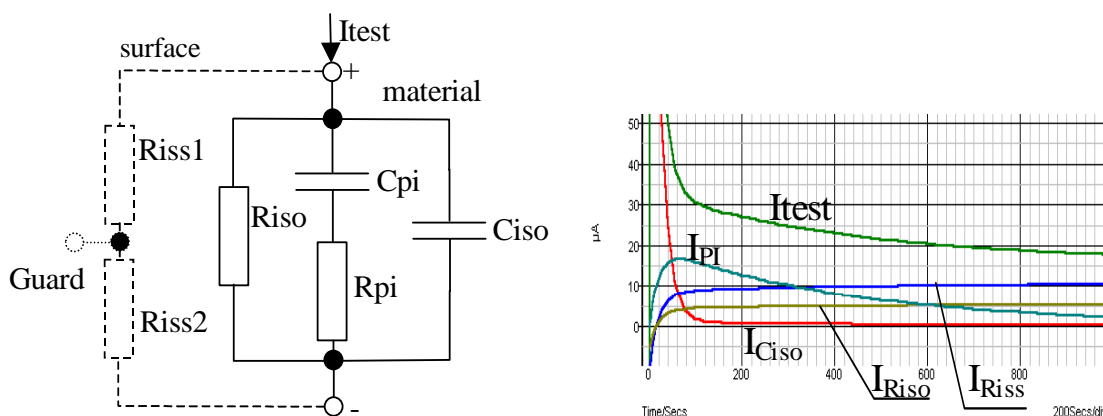

$R_{iss1}$  and  $R_{iss2}$  - the surface resistivity (position of optional guard connection)

$R_{iso}$  – the actual insulation resistance of material  
 $C_{iso}$  – capacitance of material  
 $C_{pi}, R_{pi}$  - represents polarization effects.

The right figure shows typical currents for that circuit.

$I_{test}$  = overall test current ( $I_{test} = I_{PI} + I_{RISO} + I_{RISS}$ )  
 $I_{PI}$  = polarization absorption current  
 $I_{RISO}$  = actual insulation current  
 $I_{RISS}$  = surface leakage current

**Some application examples for using Teraohm 5 kV**

**Basic Insulation resistance test**

Virtually every standard concerning the safety of electrical equipment and installations requires the performance of a basic insulation testing. When testing lower values (in the range of  $M\Omega$ ),  $R_{iso}$  usually dominates. The results are adequate and stabilize quickly.

- The voltage, time and limit are usually given in the appropriate standard or regulation.
- The suggested test voltage is often defined as 1.7 times the value of line voltage of the tested device (e.g. motor), i.e. the test voltage for a 600 V device would be 1020 VDC. Measuring time should be set to 60 s or the minimum time required for the  $C_{iso}$  to be charged up.
- Sometimes it is required to take into account the ambient temperature to adjust the result for a standard temperature of 40°C.
- If surface leakage currents interfere with the measurements (see  $R_{iss}$  above) use the guard connection (see 5.2.). This becomes critical when measuring values in the  $G\Omega$  range.

Some examples:

Standard*	Test voltage / time	End value
EN/IEC 60204	500 V	1 $M\Omega$
EN/IEC 60335-1	2000 V / 15 min	
EN/IEC 60349-1	500 V	1000 $\Omega/V$
EN/IEC 60598-1	500 V / 1 s	2 $M\Omega$

\* Only sample values are listed!

**Voltage dependence test – Step voltage test**

This test shows, if the insulation under test has been electrically or mechanically stressed. In this instance the quantity and size of insulation anomalies such as cracks, local breakdowns, conductive parts, etc. is increased and the overall breakdown voltage is reduced. Excessive humidity and pollution have an important role especially in the case of mechanical stress.

- The test voltage steps are usually close to those required in the DC withstanding test.
- Sometimes it is recommended that the maximum voltage for this test should not be higher than 60 % of withstanding voltage.

If the results of successive tests show a reduction of the tested insulation resistance the insulation should be replaced.

## Time dependence test – Diagnostic test

### POLARISATION INDEX

The purpose of this diagnostic test is to evaluate the influence of the polarization part of insulation ( $R_{pi}$ ,  $C_{pi}$ ).

After applying a high voltage to an insulator the electric dipoles distributed in the insulator align themselves with the applied electrical field. This phenomena is called polarization. As the molecules polarize, a polarization (absorption) current that lowers the overall insulation resistance occurs.

The absorption current ( $I_{pi}$ ) typically collapses after a few minutes. If the overall resistance doesn't increase, this means that other currents (e.g. surface leakages) dominate the overall insulation resistance.

- PI is defined as the ratio of the measured resistances in two time slots. The most typical ratio is 10 min value to 1 min value but not as a rule.
- The test is typically performed at the same voltage as the insulation resistance test.
- If the one-minute insulation resistance is greater than 5000 M $\Omega$ , then this measurement may not be valid (new modern types of insulation).
- Oiled paper used in transformers or motors is a typical insulation material that requires this test.

In general, insulators that are in good condition will show a "high" polarization index while insulators that are damaged will not. Note that this rule is not always valid. Refer to Metrel's handbook **Insulation Testing Techniques** for more information.

General applicable values:

PI value	Tested material status
1 to 1.5	Not acceptable (older types)
2 to 4 (typically 3)	Considered as good insulation (older types)
1 (very high insulation resistance)	Modern type of (good) insulation systems

Example for minimum acceptable values for motor insulation (IEEE 43):

Class A =1.5, Class B = 2.0, Class F =2.0, Class H =2.0.

### DIELECTRIC DISCHARGE

An additional effect of polarization is the recovered charge (from  $C_{pi}$ ) after the regular discharging of a completed test. This can also be a supplementary measurement for evaluation of the quality of insulating material. This effect is generally found in insulating systems with large capacitance  $C_{iso}$ .

DD value	Tested material status
> 4	bad
2 - 4	critical
< 2	good

## Withstanding voltage test

Some standards allow the use of a DC voltage as an alternative to AC withstanding voltage testing. For this purpose the test voltage has to be present across the insulation under test for a specific time. The test result passes if there is no breakdown or flash over. Standards recommend that the test starts with a low voltage and reaches the final test voltage with a slope that keeps the charging current (into Ciso) under the limit of the current threshold. The test normally takes 1 min.

Withstanding voltage test or dielectric test is usually applied for:

- Type (acceptance) tests when a new product is prepared for manufacture,
- Routine (production) test for verification of the safety of each product,
- Maintenance and after service test for any equipment the insulation system of which is affected to possible degradation.

Some examples for DC withstanding test voltage values:

Standard (only sample values)	Voltage
EN/IEC 61010-1 CAT II 300 V basic insulation	1970 V
EN/IEC 61010-1 CAT II 300 V double insulation	3150 V
IEC 60439-1 (clearance between live parts...), withstanding impulse voltage 4 kV, 500 m	4700 V
IEC 60598-1	2120 V

## Humidity and insulation resistance measurements

The quality of insulation resistance measurements outside the reference ambient conditions could be affected by humidity. Humidity adds leakage paths onto the surface of the complete measuring system, i.e insulator under test, test leads, measuring instrument. Its influence reduces tolerances especially in the very high resistance range – tera ohms. The worst conditions arises in case of condensation, which can also reduce the safety. In the case of high humidity it is recommended to ventilate the test areas before and during the measurements. In the case of condensed humidity the measuring system must dry and it could take several hours or even few days to recover.

## 5.2. Guard terminal

The purpose of the GUARD terminal is to lead away potential leakage currents (e.g. surface currents) which are not a result of the measured insulation material itself but of the surface contamination and moisture. This current interferes with the measurement i.e. the Insulation Resistance result is influenced by this current. The GUARD terminal is internally connected to the same potential as the negative test terminal (black one). The GUARDs test alligator should be connected to measured object so as to collect most of the unwanted leakage current, see the figure below.

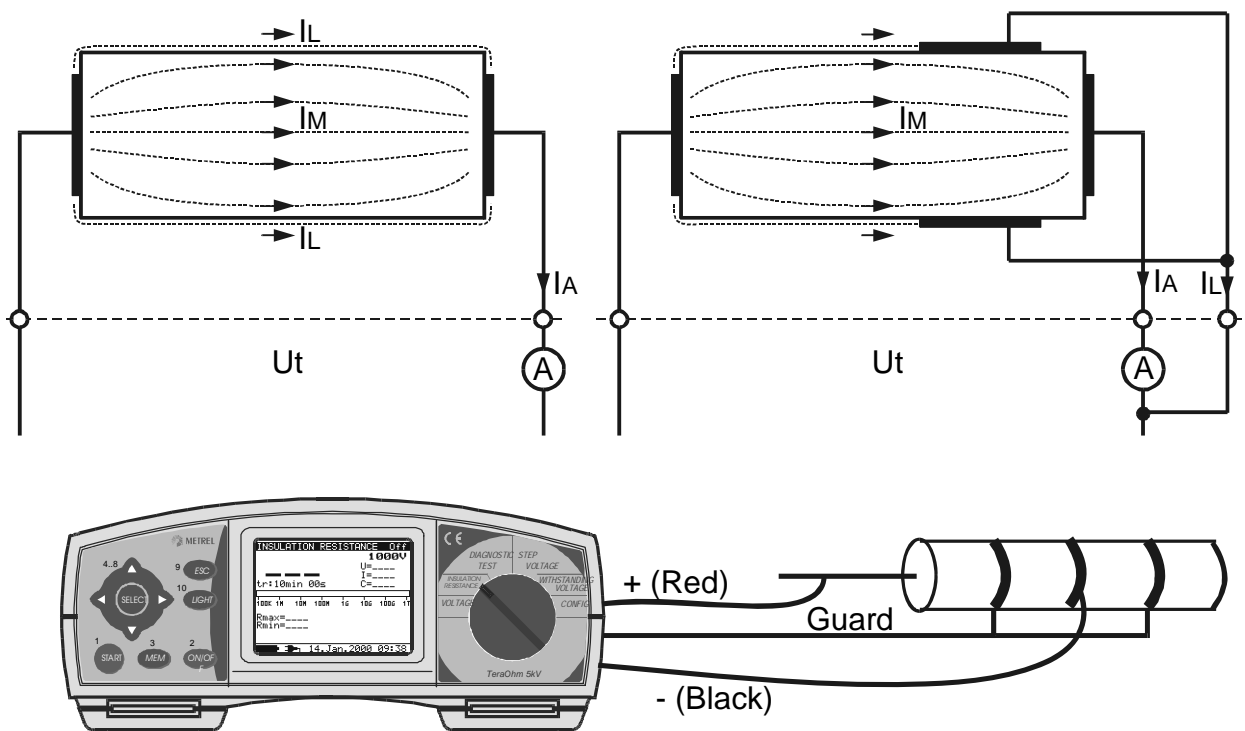

**Fig. 7.** Connection of GUARD terminal to measured object (an example for measuring cable insulation is shown)

where:

Ut..... Test voltage

IL..... Leakage current (resulted by surface dirt and moisture)

IM..... Material current (resulted by material conditions)

IA..... A-meter current

Result without using GUARD terminal:  $R_{INS} = U_t / I_A = U_t / (I_M + I_L)$  ...incorrect result.

Result using GUARD terminal:  $R_{INS} = U_t / I_A = U_t / I_M$  .....correct result.

It is recommended to use the GUARD connection when high insulation resistance (>10G  $\Omega$ ) is measured.

Note:

- Guard terminal is internal impedance (300 K $\Omega$ ) protected.

### 5.3. Filter option

Filters are built in to reduce the influence of noise on measurement results. This option enables more stable results especially when dealing with high Insulation Resistances. The table below contains a definition of the individual filter options:



Filter option	Meaning
Off	Low pass filter with cut off frequency of 0.5 Hz in signal line.
Fil1	Additional low pass filter with cut off frequency of 0.05 Hz in signal line.
Fil2	Fil1 with increased integrating time (4 s).
Fil3	Fil2 with additional cyclic averaging of 5 results.

Table 2. Filter options

## THE PURPOSE OF FILTERING

In simple terms the filters smooth the measured currents by means of averaging and bandwidth reduction. There are various sources of disturbance:

- AC currents at the mains frequency and its harmonics, switching transients etc, cause the results to become unstable. These currents are mostly crosstalk through insulation capacitances close to live systems,
- Other currents induced or coupled in the electromagnetic environment of the insulation under test.
- Ripple current from internal high voltage regulator,
- Charging effects of high capacitive loads and / or long cables.

Voltage changes are relatively narrow on high resistance insulation, so the most important point is filtering of the measured current.

### Note:

Any of the selected filter options increases the settling time with Fil1 to 60 s, Fil2 to 70 s, and Fil3 to 120 s.

- It is necessary to pay close attention to the selection of time intervals when using filters.
- The recommended minimum measuring times when using filters are the settling times of the selected filter option.

### Example 1:

A noise current of 1 mA / 50 Hz adds approximately  $\pm 15\%$  distribution to the measured result when measuring 1 G $\Omega$ .

By selecting FIL1 option the distribution will reduce to less than  $\pm 2\%$ .

In general using FIL2 and FIL3 will further improve the noise reduction.

### Example 2:

Testing an object with the following parameters:

$U_{test} = 250\text{ V}$ ,  $I_{noise} = 3\text{ mA}$ ,  $R = 2.4\text{ G}\Omega$ ,  $C = 220\text{ nF}$

Filter options give following results:

OFF: distribution of results 30 %,

Fil1: distribution of results 3.5 %,

Fil2: distribution of results 1.5 %,

Fil3: distribution of results 0.9%.

For this example the setup time is also increased and for the Fil3 option, the time to capture the first good result (Time1) is approximately 2 min.

## 5.4. Voltage measurement

Selecting this function displays the following states (initial state and state with results after completion of the measurement).

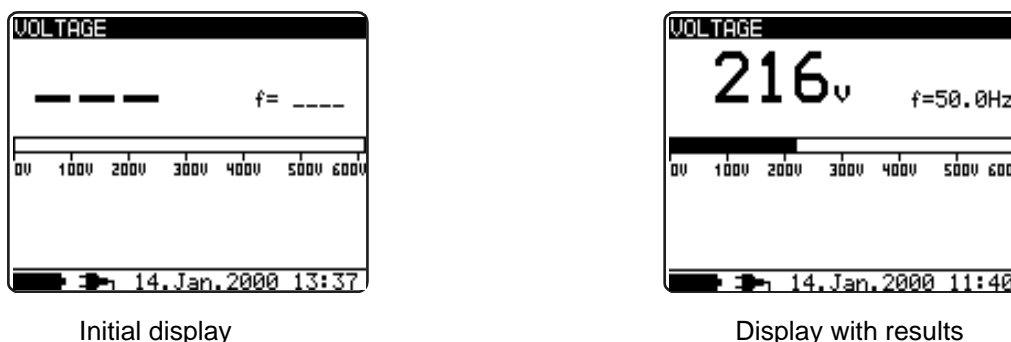

**Fig. 8.** Voltage function display states

### Measurement procedure:

- Connect the test leads to the instrument and to the measured source.
- Press the **START** key to start the measurement, continuous measurement starts to run.
- Press the **START** key again to stop the measurement.
- The result (see the right figure above) can optionally be saved by pressing the **MEM** key twice, see the chapter 6.1. Store, Recall and Clear Operation.

### Warning!

- Refer to Warnings chapter for safety precautions!

## 5.5. Insulation Resistance measurement

Selecting this function displays the following states (initial state and state with results after the completion of the measurement).

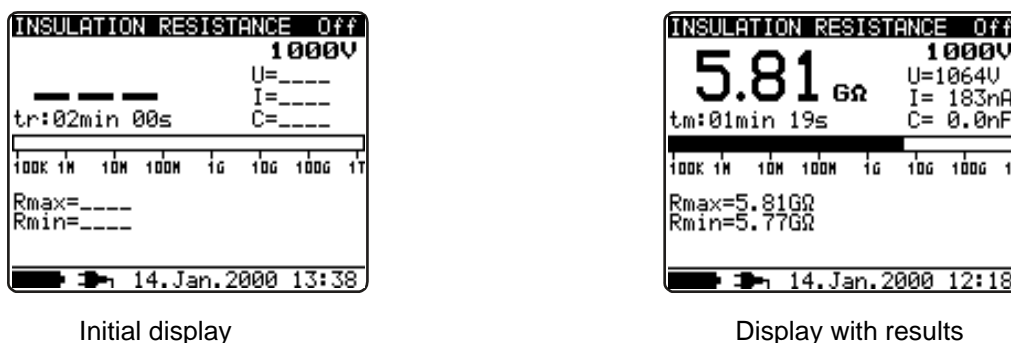

**Fig. 9.** Insulation Resistance function display states

**Measurement procedure:**

- Connect the test leads to the instrument and to the tested object.
- Select **INSULATION RESISTANCE** function using the rotary switch knob.
- Press the **START** key and release it, continuous measurement starts to run.
- Wait until the test result has stabilized then press the **START** key again to stop the measurement or until set timer runs out (if enabled).
- Wait for the object under test to be discharged.
- The result (see the right figure above) can optionally be saved pressing the **MEM** key twice, see the chapter 6.1. Store, Recall and Clear Operation.

Legend of displayed symbols:

<b>INSULATION RESISTANCE</b>	Name of selected function
Off (Fil1, Fil2, Fil3)	Filter type enabled, see the chapter 5.3. Configuration
<b>1000V</b>	Set test voltage
U=1056V	Actual test voltage – measured value
I=0.04nA	Actual test current – measured value
<b>&gt;1.00TΩ</b>	Insulation Resistance – <b>result</b>
C=1.3nF	Capacitance of measured object
tm:00min 15s	Timer information – test duration
Bar	Analog presentation of result
Rmax=	Maximum value of result (only if timer is enabled)
Rmin=	Minimum value of result (only if timer is enabled)

**Notes:**

- If the timer is disabled then **OFF** is displayed instead of the timer value.
- During the measurement the timer information displays the time needed for the completion of the measurement (tr) while after the completion the test duration (tm) is displayed.
- A high-voltage warning symbol appears on the display during the measurement to warn the operator of a possible dangerous test voltage.
- Value of capacitance is measured during the final discharge of the measured object.

**Set-up parameters** for Insulation Resistance:

- Press the **SELECT** key, Set-up menu appears on display, see the figure 10.
- Select parameter (line) to be set using the ↑ and ↓ keys;
- Adjust set parameter using the ← and → keys. Skip to the next sub-parameter by pressing the **SELECT** key (if there are two or more sub-parameters) and repeat the adjustment.
- Complete the set-up adjustments pressing either the **ESC** key or **START** key (to run the measurement directly) or changing the rotary switch position. Last displayed settings are stored.

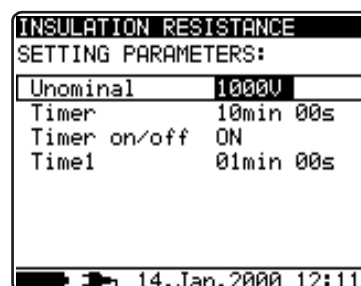

**Fig. 10.** Set-up menu in Insulation Resistance measurement

Legend of displayed symbols:

INSULATION RESISTANCE		Name of selected function
SETTING PARAMETERS:		
Unominal	1000V	Set test voltage – step 50 V
Timer	10min 00s	Duration of measurement
Timer on/off	ON	ON: timer enabled, OFF: timer disabled
Time1	01min 00s	Time to accept and display first Rmin and Rmax result

Timer and Time1 are independent timers. Maximum time for each of them is 30 min 60 s.

### Warning!

- Refer to Warnings chapter for safety precautions!

## 5.6. Diagnostic test

Selecting this function displays the following states (initial state and state with results after the completion of the measurement).

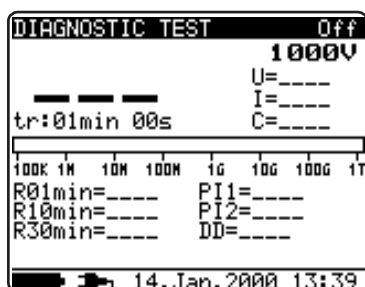

Initial display

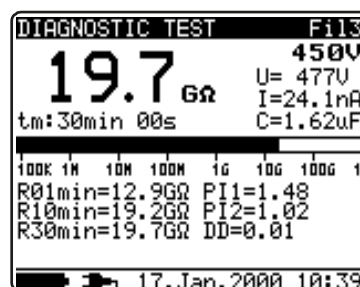

Display with results

Fig. 11. Diagnostic test display states

This is a long duration test for evaluating the quality of the insulation material under test. The results of this test enable a decision to be made on the preventive replacement of the insulation material.

### DIELECTRIC ABSORPTION RATIO (DAR)

DAR is ratio of Insulation Resistance values measured after 15s and after 1minute. The DC test voltage is present during the whole period of the measurement (also Insulation Resistance measurement is running). At the end DAR ratio is displayed:

$$DAR = \frac{R_{iso}(1min)}{R_{iso}(15s)}$$

Some applicable values:

DAR value	Tested material status
< 1.25	Not acceptable
< 1.6	Considered as good insulation
> 1.6	Excellent

Note: When determining Riso (15s) pay attention to the capacitance of tested object. It has to be charged-up in the first time section (15s). Approximate maximum capacitance using:

$$C_{\max} [\mu F] = \frac{t [s] 10^3}{3 \cdot U [V]}$$

where:

t..... period of first time unit (e.g. 15s)

U ..... test voltage.

To avoid this problem increase **DIAG. Starting time** parameter in CONFIGURATION menu, because start of timer in DIAGNOSTIC TEST functions depends on output test voltage. Timer begins to run when output test voltage reaches threshold voltage, which is product of parameters **DIAG. Starting time** and **Unominal** (nominal test voltage). Using filters (fil1,fil2,fil3) in DAR function is not recommended!

Analyzing trend of measured insulation resistance and calculation of DAR and PI are very useful maintenance tests of insulating material.

### POLARIZATION INDEX (PI)

PI is the ratio of Insulation Resistance values measured after 1 minute and after 10 minutes. The DC test voltage is present during the whole period of the measurement (also Insulation Resistance measurement is running). On completion of the test the PI ratio is displayed:

$$PI = \frac{R_{iso} (10 \text{ min})}{R_{iso} (1 \text{ min})}$$

Note: When determining Riso (1min) pay close attention to the capacitance of the object under test. It has to be charged-up in the first time section (1 min). Approximate maximum capacitance using:

$$C_{\max} [\mu F] = \frac{t [s] 10^3}{3 \cdot U [V]}$$

where:

t..... period of first time unit (e.g. 1min)

U ..... test voltage.

To avoid this problem increase **DIAG. Starting time** parameter in CONFIGURATION menu, because start of timer in DIAGNOSTIC TEST functions depends on output test

voltage. Timer begins to run when output test voltage reaches threshold voltage, which is product of parameters **DIAG. Starting time** and **Unominal** (nominal test voltage).

Analyzing trend of measured insulation resistance and calculation of DAR and PI are very useful maintenance tests of insulating material.

### DIELECTRIC DISCHARGE TESTING (DD)

DD is the diagnostic insulation test carried out after the completion of the Insulation Resistance measurement. Typically the insulation material is left connected to the test voltage for 10 ÷ 30 min and then discharged before DD test is carried out. After 1 minute a discharge current is measured to detect charge re-absorption of the insulation material. A high re-absorption current indicates contaminated insulation mostly based on moisture:

$$DD = \frac{I_{dis1\ min}[mA]}{U[V] \cdot C[F]},$$

where:

$I_{dis\ 1\ min}$  .....discharging current measured 1 min after regular discharge

U .....test voltage

C .....capacitance of tested object.

#### Measurement procedure:

- Connect the test leads to the instrument and to the measured object.
- Press the **START** key to start the measurement.
- Wait until set timer runs out, result is displayed.
- Wait until the object under test has discharged
- The result (see the right part of the figure 11.) can optionally be saved by pressing the **MEM** key twice, see the chapter 6.1. Store, Recall and Clear Operation.

Legend of displayed symbols:

<b>DIAGNOSTIC TEST</b>	Name of selected function
<b>Off (Fi11, Fi12, Fi13)</b>	Filter type enabled, see the chapter 5.3. Configuration
1000V	Set test voltage – step 50 V
U=1056V	Actual test voltage – measured value
I=0.04nA	Actual test current – measured value
<b>&gt;1.00TΩ</b>	Insulation Resistance – <b>result</b>
C=1.3nF	Capacitance of measured object
tr:00min 15s	Set timer value
bar	Analog presentation of Riso result
R01min=>1TΩ	Resistance value measured after set time 1
R02min=>1TΩ	Resistance value measured after set time 2
R03min=>1TΩ	Resistance value measured after set time 3
DAR=1.67	DAR as ratio of R01min / R15s
PI=1.21	PI as ratio of R03/R02
DD=___	DD result

**Notes:**

- A high-voltage warning symbol appears on the display during the measurement to warn the operator of a possible dangerous test voltage.
- The value of capacitance is measured during the final discharge of the measured object.
- If enabled, the instrument measures DD when the measured capacitance is in the range of 5 nF to 50 μF.

**Set-up parameters** for Diagnostic Test:

- Press the **SELECT** key, Set-up menu appears on display, see the figure 12.
- Select parameter (line) to be set using the ↑ and ↓ keys;
- Adjust set parameter using the ← and → keys.
- Complete the set-up adjustments pressing either the **ESC** key or **START** key (to run the measurement directly) or changing the rotary switch position. Last displayed settings are stored.

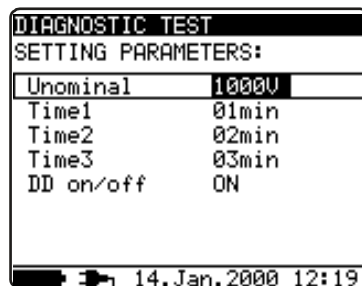
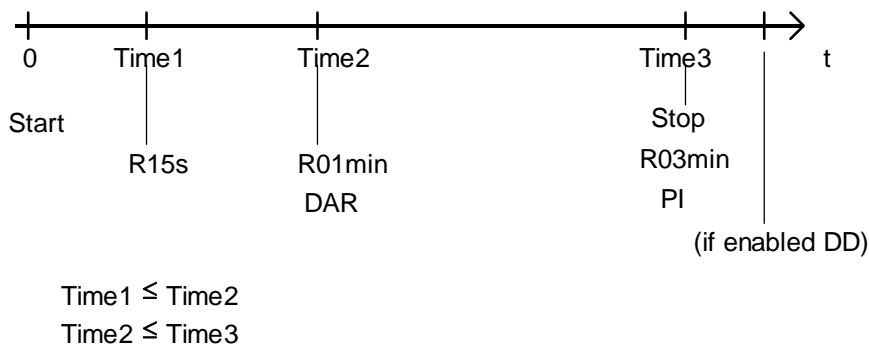

**Fig. 12.** Set-up menu in Diagnostic Test

Legend of displayed symbols:

DIAGNOSTIC TEST		Name of selected function
SETTING PARAMETERS:		
Unominal	1000V	Set test voltage – step 50 V
Time1	01min	Time node to take R01min result
Time2	02min	Time node to take R01min result and calculate DAR
Time3	03min	Time node to take R03min result and calculate PI
DD on/off	ON	ON: DD enabled, OFF: DD disabled

Time1, Time2 and Time3 are timers with the same start point. The value of each presents the duration from the start of the measurement. Maximum time is 30 min. The following figure shows the timer relationship.



**Fig. 13.** Timer relations

**Warning!**

- Refer to Warnings chapter for safety precautions!

## 5.7. Step Voltage Insulation Resistance testing

Selecting this function displays the following states (initial state and state with results after the completion of the measurement).

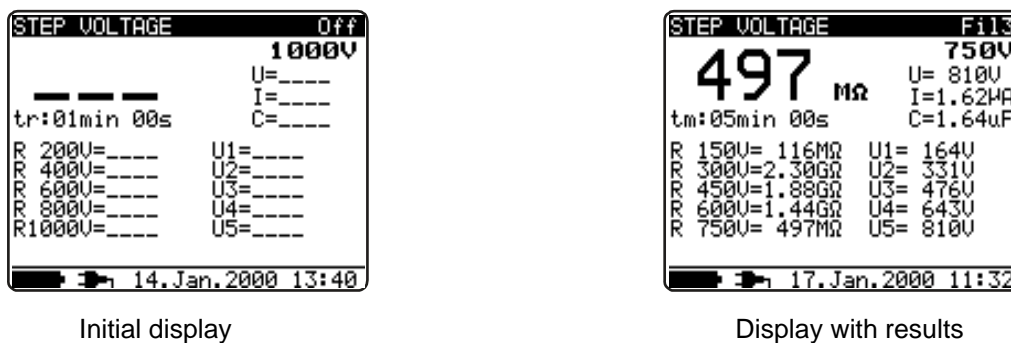
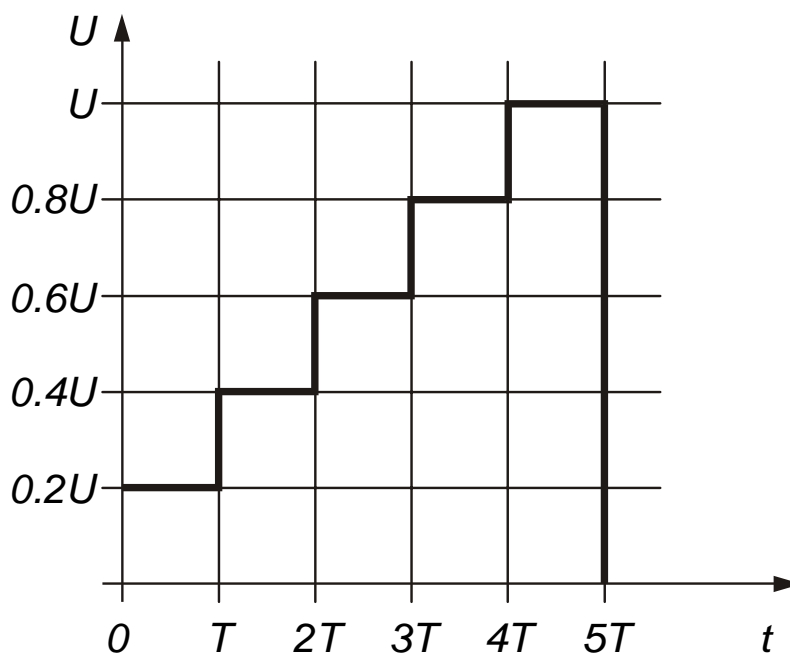

**Fig. 14.** Step Voltage Insulation Resistance function display states

Insulation is measured in five equal time periods at test voltages from one fifth up to full scale, see the figure 15. This function shows the level of the measured Insulation Resistance versus the test voltage.

### Measurement procedure:

- Connect the test leads to the instrument and to the measured object.
- Press the **START** key to start the measurement.
- Wait until set timer runs out, result is displayed.
- Wait until the object under test has discharged
- The result (see the right part of the figure 14.) can optionally be saved by pressing the **MEM** key twice, see the chapter 6.1. Store, Recall and Clear Operation.



**Fig. 15.** Step-up test voltage



Legend of displayed symbols:

<b>STEP VOLTAGE</b>	Name of selected function
<b>Off (Fil1, Fil2, Fil3)</b>	Filter type enabled, see the chapter 5.3. Configuration
1500V	Set test voltage – step 250 V
U=1593V	Actual test voltage – measured value
I=0.00nA	Actual test current – measured value
<b>&gt;1.50TΩ</b>	Insulation Resistance – <b>result</b>
C=0.6nF	Capacitance of measured object
tm:05min 15s	Actual test duration
R 300V=>300GΩ	Last result of 1 <sup>st</sup> step
R 600V=>600GΩ	Last result of 2 <sup>nd</sup> step
R 900V=>900GΩ	Last result of 3 <sup>rd</sup> step
R1200V=>1.2TGΩ	Last result of 4 <sup>th</sup> step
R1500V=>1.5TΩ	Last result of 5 <sup>th</sup> step
U1= 343V	1 <sup>st</sup> step voltage
U2= 655V	2 <sup>nd</sup> step voltage
U3= 948V	3 <sup>rd</sup> step voltage
U4=1284V	4 <sup>th</sup> step voltage
U5=1593V	5 <sup>th</sup> step voltage

#### Notes:

- Timer information is displayed from the start of the measurement until the completion of each step measurement.
- Timer information shows the complete measurement period after the completion of the measurement.
- A high-voltage warning symbol appears on the display during the measurement to warn the operator of a possible dangerous test voltage.
- The value of capacitance is measured during the final discharge of measured object.

#### Set-up parameters for Step Voltage test:

- Press the **SELECT** key, Set-up menu appears on display, see the figure 16.
- Select parameter (line) to be set using the  $\uparrow$  and  $\downarrow$  keys;
- Adjust set parameter using the  $\leftarrow$  and  $\rightarrow$  keys.
- Complete the set-up adjustments by pressing either the **ESC** key or **START** key (to run the measurement directly) or changing the rotary switch position. Last displayed settings are stored.

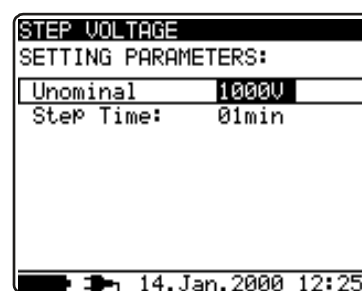

Fig. 16. Set-up menu in Step Voltage Test

Legend of displayed symbols:

<b>STEP VOLTAGE</b>	Name of selected function
SETTING PARAMETERS:	
Unominal	1000V Set test voltage – step 250 V
Step Time	01min Duration of measurement per step

**Note:**

- Maximum value for Step Time is 30 min.

**Warning!**

- Refer to Warnings chapter for safety precautions!

## 5.8. Withstanding voltage

This function offers Withstanding Voltage test of insulation material. It covers two types of tests:

- Breakdown voltage testing of high voltage device, e.g. transient suppressors and
- DC withstanding voltage test for insulation coordination purposes.

Both functions require breakdown current detection. The test voltage increases step by step from the Start up to the Stop value over a predefined time and it is kept at the Stop value for a predefined test time, see the figure below.

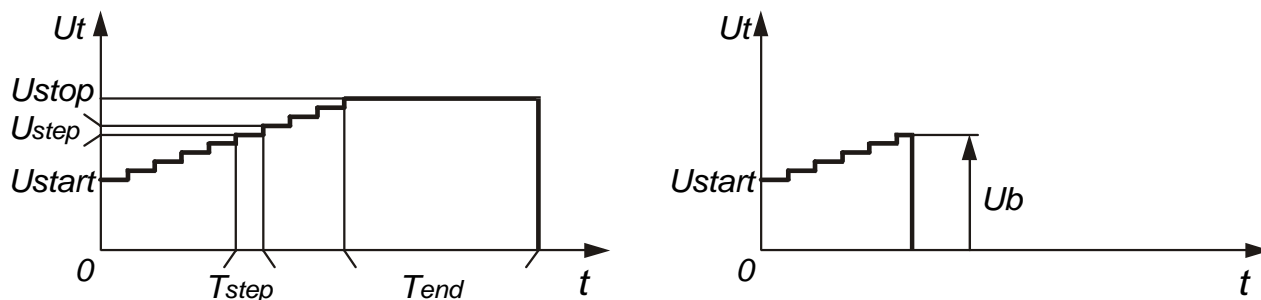

**Fig. 17.** Test voltage presentation without breakdown (left part) and with breakdown (right part)

$U_t$ ..... Test voltage

$U_{stop}$  .. End test voltage

$U_{step}$  .. Voltage step approx. 20 V (fixed value - not presetable)

$U_{start}$ .. Initial test voltage

$T_{step}$ ... Test voltage duration per one step

$T_{end}$  ... Constant test voltage duration after reaching End value

$t$ ..... Time

$U_b$ ..... Breakdown voltage

Selecting this function displays the following states (initial state and state with results after completion of the measurement).

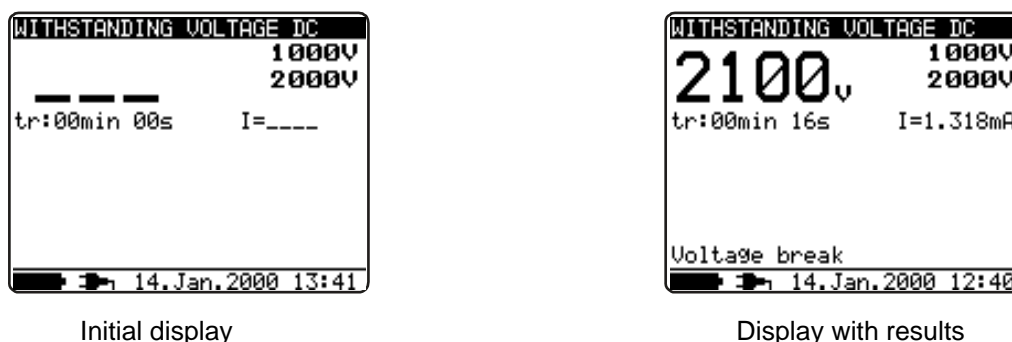

**Fig. 18.** Withstanding Voltage function display states

### Measuring procedure:

- Connect the test leads to the instrument and to the measured object.
- Press the **START** key to start the measurement.
- Wait until the set timers run out or until breakdown occurs, the result is displayed.
- Wait until the object under test is discharged.
- The result (see the right part of the figure 18.) can optionally be saved by pressing the **MEM** key twice, see the chapter 6.1. Store, Recall and Clear Operation.

### Note:

- Breakdown is detected when the measured current reaches or exceeds the set current level  $I_{trig}$ .

Legend of displayed symbols:

WITHSTANDING VOLTAGE DC	Name of selected function
1000V	Start test voltage
2000V	Stop test voltage
2053V	Actual test voltage – measured value
I=0.04nA	Actual test current – measured value
tm:01min 00s	Timer information

### Notes:

- Timer information shows the time needed to accomplish each step during the measurement and it shows the total measurement period after the completion of the measurement.
- A high-voltage warning symbol appears on the display during the measurement to warn the operator of a possible dangerous test voltage.

Legend of displayed symbols:

WITHSTANDING VOLTAGE DC	Name of selected function	
SETTING PARAMETERS:		
Ustart	1000V	Start test voltage, step = 50 V
Ustop	2000V	Stop test voltage, step = 50 V
Tstep	00min 00s	Duration of test voltage per one step
Tend	00min 00s	Duration of constant test voltage after reaching stop value
Itrigg	1.000mA	Set trigger leakage current, step = 10 $\mu$ A

**Set-up parameters** for Withstanding Voltage:

- Press the **SELECT** key, Set-up menu appears on display, see the figure 19.
- Select parameter (line) to be set using the  $\uparrow$  and  $\downarrow$  keys;
- Adjust set parameter using the  $\leftarrow$  and  $\rightarrow$  keys. Skip to the next sub-parameter by pressing the **SELECT** key (if there are two or more sub-parameters) and repeat the adjustment.
- Complete the set-up adjustments pressing either the **ESC** key or **START** key (to run the measurement directly) or changing the rotary switch position. The last displayed settings are stored.

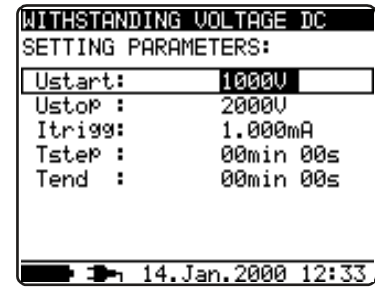

**Fig. 19.** Set-up menu in Withstanding Voltage function

$T_{step}$  and  $T_{end}$  are independent timers. The maximum time for each timer is 30 min 60 s.  $T_{end}$  begins after the completion of the ramp period. Ramp period can be calculated from:

$$Tramp \approx T_{step} \cdot (U_{stop} - U_{start}) / 20 \text{ V}$$

If  $T_{step}$  is set to 00min 00s, then the ramp voltage increases by approximately 20 V per 2s.

**Warning!**

- Refer to Warnings chapter for safety precautions!

## 6. Operation with Results

### 6.1. Store, Recall and Clear Operation

The instrument contains battery backup storage to retain the stored results. This is to enable the user first to make the measurements and later to recall them, analyze and print results or transfer them to a computer for further analysis.

After pressing the **MEM** key menu according to the figure 20. is displayed. Save, clear and recall operations are offered.

**SAVE** CLR RCL nnnn

The **nnnn** means ser. number of stored result.

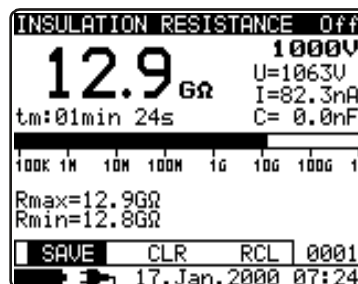

**Fig. 20.** Storage operation menu

There are the following possibilities, selectable with ← or → arrow keys:

- To store result: Select **SAVE** and confirm store operation by pressing the **MEM** key.
- To recall stored result: Select **RCL** and confirm recall operation by pressing the **MEM** key, the last stored result will be displayed. The upper menu is replaced with:

Recall: 0006

Figure 0006 presents the ser. No. of the stored result. By using the ↑ and ↓ keys also the other stored results can be recalled. Press the **ESC** or **Start** key or turn the rotary switch to exit this menu.

- To clear the last stored result: select **CLR** and press the **MEM** key.

To clear the complete memory see paragraph 4.2. Configuration.

In addition to the main result also the subresults and parameters of the selected function are recorded. The following is a list of all data stored for each function.

Function	List of stored data
<b>Voltage</b>	Function name Measured voltage Frequency of measured voltage Ser. number of stored result Date * Time *
<b>Insulation resistance</b>	Function name Measured insulation resistance value Set test voltage Actual test voltage - measured value Actual test current - measured value Capacitance of tested object Duration of measurement Detected maximum value of measured resistance Detected minimum value of measured resistance Ser. number of stored result Date * Time *
<b>Diagnostic test</b>	Function name Last measured insulation resistance Set test voltage Actual test voltage - measured value Actual test current - measured value Capacitance of tested object Complete duration of measurement Insulation Resistance value taken after elapsed T1 Insulation Resistance value taken after elapsed T2 Insulation Resistance value taken after elapsed T3 DAR value PI value DD value Ser. number of stored result Date * Time *
<b>Withstanding voltage DC</b>	Function name Last measured test voltage Set Start voltage Set Stop voltage Set trigger current value Actual test current - measured value Set Step test time Set End time Actual test time (at Stop test voltage) Ser. number of stored result Date * Time *

<b>Step voltage</b>	Function name Last measured insulation resistance Set test voltage Actual test voltage - measured value Actual test current - measured value Capacitance of tested object Complete duration of measurement First step measured resistance with its nominal voltage First step actual test voltage - measured value Second step measured resistance with its nominal voltage Second step actual test voltage - measured value Third step measured resistance with its nominal voltage Third step actual test voltage - measured value Fourth step measured resistance with its nominal voltage Fourth step actual test voltage - measured value Last step measured resistance with its nominal voltage Last step actual test voltage - measured value Ser. number of stored result Date * Time *
---------------------	----------------------------------------------------------------------------------------------------------------------------------------------------------------------------------------------------------------------------------------------------------------------------------------------------------------------------------------------------------------------------------------------------------------------------------------------------------------------------------------------------------------------------------------------------------------------------------------------------------------------------------------------------------------------------------------------------------------------------------------------------------------------------------------------------------------------------------------------------------

**Note:**

- \*Date and time **of storing** the test result are transferred to PC while date and time **of recalling** are displayed when recalling results.

## 6.2. Data transfer

Stored results can be transferred to a PC. A special communication program has the ability to identify the instrument and download the data.

**How to transfer the stored data:**

- Connect PC COM port to the instrument using the serial communication cable.
- Power up both the PC and the instrument.
- Run the program **Teralink.exe**.
- The PC and the instrument automatically recognize each other.
- The program on the PC enables the following possibilities:
  - download data;
  - clear storage;
  - change and download user data;
  - prepare a simple report form;
  - prepare a file to import to a spreadsheet.

The program **Teralink.exe** is a Windows 2000/XP based PC software. Read file README.TXT for instructions on installing and running the program.

## 7. Maintenance

### 7.1. Inspection

To maintain the operator's safety and to ensure the reliability of the instrument it is advisable to inspect the instrument on a regular basis. Check that the instrument and its accessories are not damaged. If any defect is found please consult your service center, distributor or manufacturer.

### 7.2. Battery Replacement

The instrument is designed to be powered by rechargeable battery supported with mains supply. The LCD contains an indication of low battery condition. When the low-battery indication appears the battery has to be replaced or recharged, connect the instrument to the mains power supply for 14 hours to recharge cells battery (2200 mAh). Typical charging currents is 150 mA.

**Note:**

- Operator does not need to disconnect the instrument from mains supply after the full recharging period. The instrument can be connected permanently.

Battery cells are stored in the bottom section of the instrument casing under the battery cover. In case of defective battery please note the following:

- ◆ **All six cells have to be replaced and they have to be of the same type.**
- ◆ **Turn the power off and disconnect any measurement accessory connected to the instrument before opening the battery cover to avoid electric shock.**
- ◆ **Do not operate the instrument by mains supply without rechargeable batteries in order to avoid permanent damage of internal circuitry.**

Nominal power supply voltage is 7.2 V DC. Use six NiCd or NiMH cells with size equivalent to IEC LR14 (dimensions: diameter = 26 mm, height = 50 mm). See the next figure for correct polarity of batteries.

Fully charged rechargeable battery can supply the instrument for approx. 20 hours.

**Note:**

- Standard IEC LR14 type alkaline cells can also be used to replace rechargeable battery. **Avoid connection to mains supply when alkaline batteries are inserted, danger of explosion.** High quality alkaline batteries can supply the instrument for approx. 60 hours.



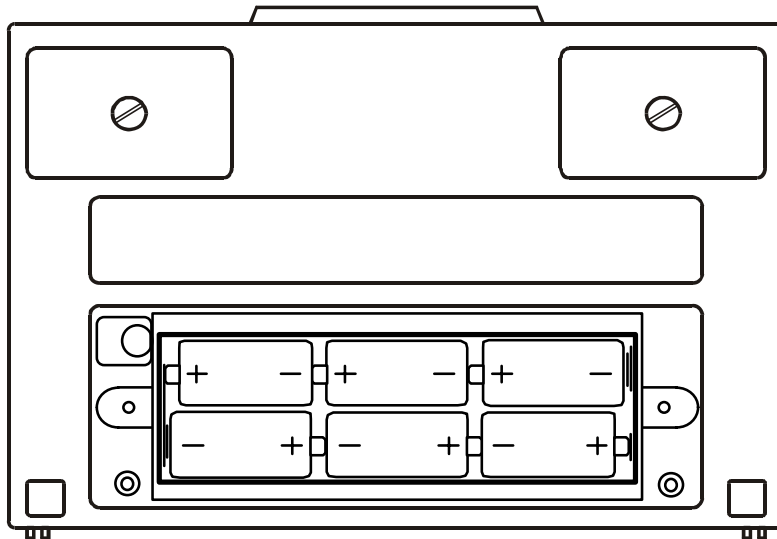

**Fig. 21.** Correct polarity of inserted batteries

**Notes!**

- Insert cells correctly, otherwise test instrument will not operate and battery may be discharged!
- If the instrument is not to be used for a long period of time remove all batteries from battery compartment.
- Take into account handling and maintenance as defined by the manufacturer of battery cells in use.

### 7.3. Cleaning

Use a soft cloth slightly moistened with soapy water or spirit to clean the surface of the instrument and leave the instrument to dry totally before using it.

**Notes!**

- Do not use liquids based on petrol or hydrocarbons!
- Do not spill cleaning liquid over the instrument!

### 7.4. Calibration

It is essential that all measurement instruments be regularly calibrated. For occasional daily use, we recommend an annual calibration to be carried out. When the instrument is used continuously every day, we recommend calibrating the instrument every six months.

### 7.5. Service

For repairing under or out of warranty period contact your distributor for further information.

## 8. Specifications

### 8.1. Measurements

#### Insulation resistance

Nominal test voltage:	Any within 250 and 5000 V
Current capability of test generator:	>1 mA
Short-circuit test current:	1.4 mA max.
Automatic discharge of tested object:	yes

Measuring range Riso: 0.12 MΩ up to 5 TΩ\*)

Display range Riso	Resolution	Accuracy
0 ÷ 999 kΩ	1 kΩ	±(5 % of reading + 3 digits)
1.00 ÷ 9.99 MΩ	10 kΩ	
10.0 ÷ 99.9 MΩ	100 kΩ	
100 ÷ 999 MΩ	1 MΩ	
1.00 ÷ 9.99 GΩ	10 MΩ	
10.0 ÷ 99.9 GΩ	100 MΩ	
100 ÷ 999 GΩ	1 GΩ	
1.00 ÷ 5.00 TΩ	10 GΩ	

\* Full-scale value of insulation resistance is defined according the following equation:

$$R_{FS} = 1T\Omega * U_{test}[kV]$$

#### DC test voltage:

Voltage value:	Any value within 250 V and 5000 V, steps by 50 V.
Accuracy:	-0 / +10 % + 20 V.
Output power:	5 W max.

Display range Test voltage (V)	Resolution	Accuracy
0 ÷ 5000	1 V	±(3 % of reading + 3 V)

#### Current:

Display range I (mA)	Resolution	Accuracy
1 ÷ 1.4 mA	10 μA	±(5 % of reading + 0.05 nA)
100 ÷ 999 μA	1 μA	
10 ÷ 99.9 μA	100 nA	
1 ÷ 9.99 μA	10 nA	
100 ÷ 999 nA	1 nA	
10 ÷ 99.9 nA	0.1 nA	
0 ÷ 9.99 nA	0.01 nA	

#### Noise current rejection (resistive load)

Filter option	Maximum current @ 50Hz (mA r.m.s).
OFF	1.5
Fil1	2.5
Fil2	4.5
Fil3	5

## Generator Capability vs. Resistance

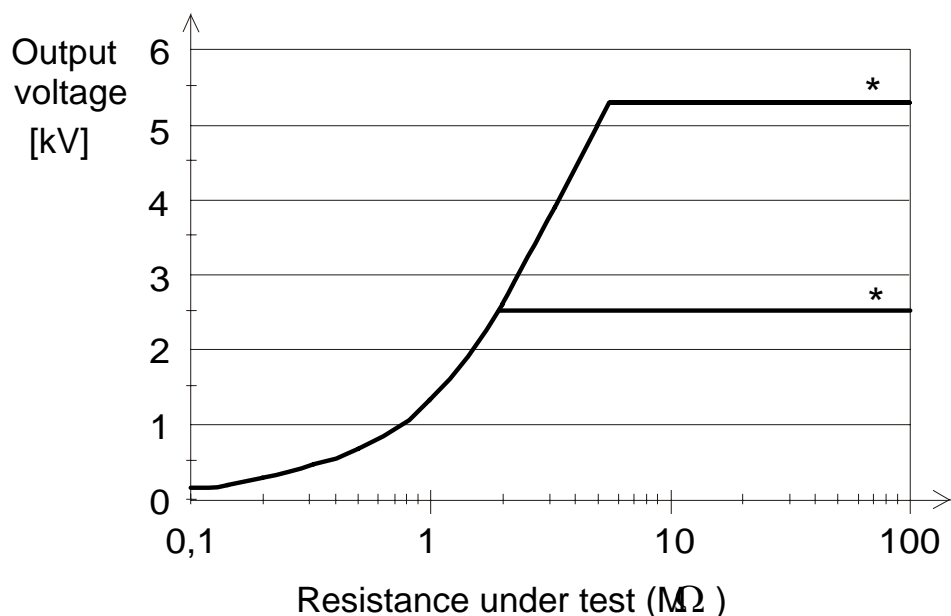

\* Note: examples of selected output voltage

### Withstanding voltage

Voltage DC

Display range Withstanding voltage (V)	Resolution	Accuracy
0 ÷ 5500	1 V	±(3 % of reading + 40 V)

Leakage current

Display range Itrigg (mA)	Resolution	Accuracy
0 ÷ 1.4	1 μA	±(3 % of reading + 3 digits)

### Voltage

Voltage AC or DC

Display range External Voltage (V)	Resolution	Accuracy
0 ÷ 600	1 V	±(3 % of reading + 3 V)

Frequency of external voltage

Display range (Hz)	Resolution	Accuracy
0 and 45 ÷ 65	0.1 Hz	±0.2 Hz

Note:

- for frequency between 0 and 45 Hz      displayed <45 Hz
- for frequency over 65 Hz                displayed >65 Hz

Input resistance: 3 MΩ ± 10 %

**Capacitance**Measuring range C: 50  $\mu$ F\*

Display range C	Resolution	Accuracy
0 ÷ 99.9 nF	0.1 nF	±(5 % of reading + 2 digits)
100 ÷ 999 nF	1 nF	
1 ÷ 50 $\mu$ F	10 nF	

\*Full-scale value of capacitance is defined according to the following equation:

$$C_{FS} = 10\mu F * U_{test}[kV]$$

**Dielectric absorption ratio DAR**

Display range DAR	Resolution	Accuracy
0 ÷ 99.9	0.01	±(5% of reading + 2digits)

**Polarization index PI**

Display range PI	Resolution	Accuracy
0 ÷ 99.9	0.01	±(5 % of reading + 2 digits)

**Dielectric discharge test DD**

Display range DD	Resolution	Accuracy
0 ÷ 99.9	0.01	±(5 % of reading + 2 digits)

Capacitance range for DD test: 5 nF to 50  $\mu$ F.**8.2. General specifications**

Battery power supply .....	7.2 V – 9 V DC (6 × 1.2V NiCd or NiMH IEC LR14)
Mains power supply .....	230V AC (+6/-10 %) 45 Hz – 65 Hz, 25 VA
Optional on request .....	115V AC (+6/-10 %) 45 Hz – 65 Hz, 25 VA
Protection classification .....	double insulation <input type="checkbox"/>
Over-voltage category .....	CAT III 600 V
Pollution degree.....	2
Degree of protection .....	IP 44
Dimensions (w × h × d).....	26.5 × 11 × 18.5 cm
Weight (without accessories, with batteries) ..	2.1 kg
Visual and sound warnings.....	yes
Display.....	LCD dot matrix with backlight - (160 x 116)
Memory.....	Non-volatile internal memory 1000 measurements with time and date.
Working temperature range .....	-10 ÷ 50 °C
Nominal (reference) temperature range.....	10 ÷ 30 °C
Storage temperature range.....	-20 ÷ +70 °C.
Maximum humidity .....	95 % RH (0 ÷ 40 °C) non-condensing
Nominal (reference) humidity range.....	40 ÷ 60 % RH

**AUTOCALIBRATION**

Auto-calibration of measuring system..... every time after turning power on

CONNECTING SYSTEM

Three safety banana sockets..... +OUT, -OUT and GUARD.

Guard resistance ..... 300 k $\Omega$

DISCHARGING

Every time after measurement completion.

Discharging resistance: ..... 100 k $\Omega$   $\pm$  10 %

SERIAL COMMUNICATION

RS232 serial communication ..... galvanic separated

Baud rates: ..... 2400, 4800, 9600, 19200 baud, 1 stop bit,  
no parity.

Connector: ..... standard RS232 9-pin D female.

CLOCK

Built-in Real time clock ..... Displayed permanently and stored as a  
parameter in combination with the result.





